

ESL CONNECTION DIAGRAM

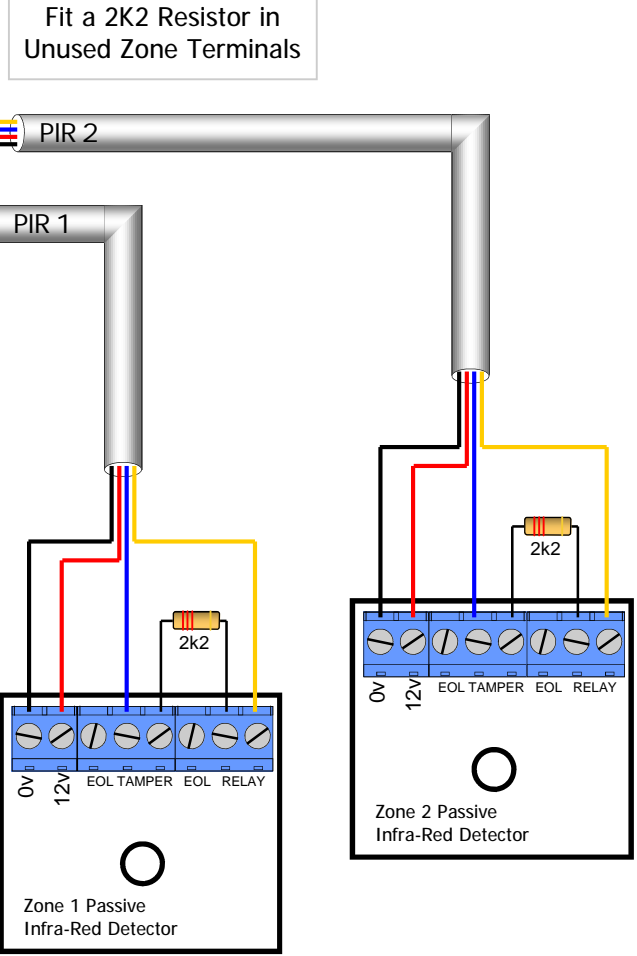
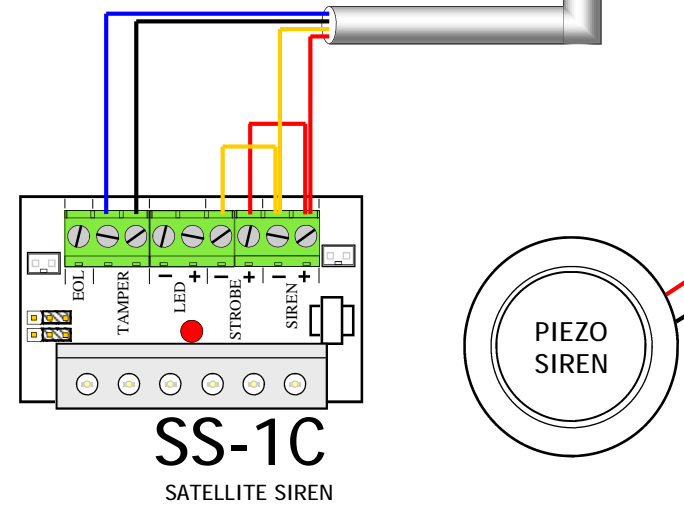
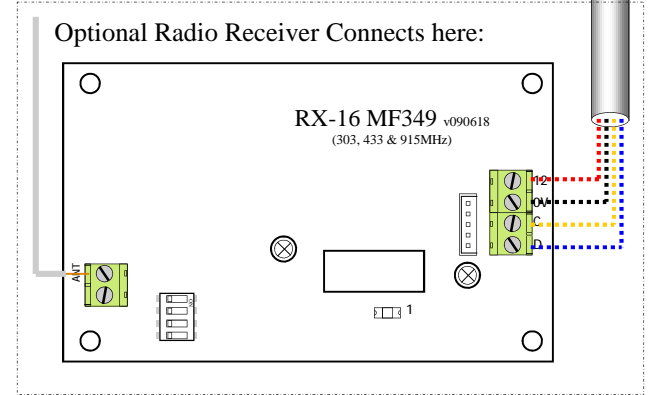
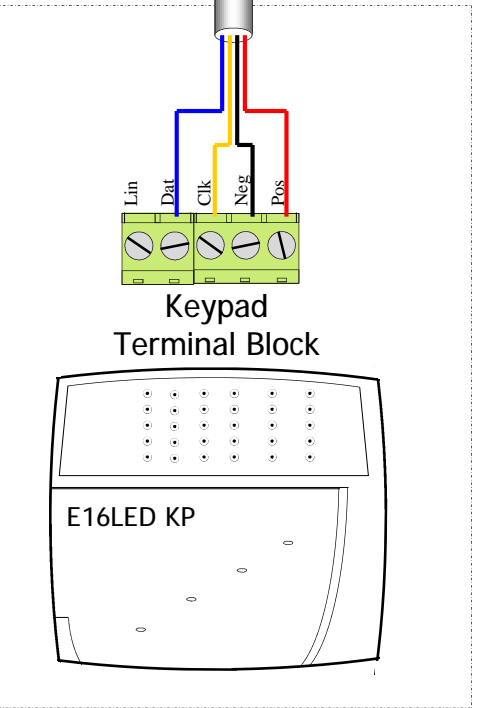
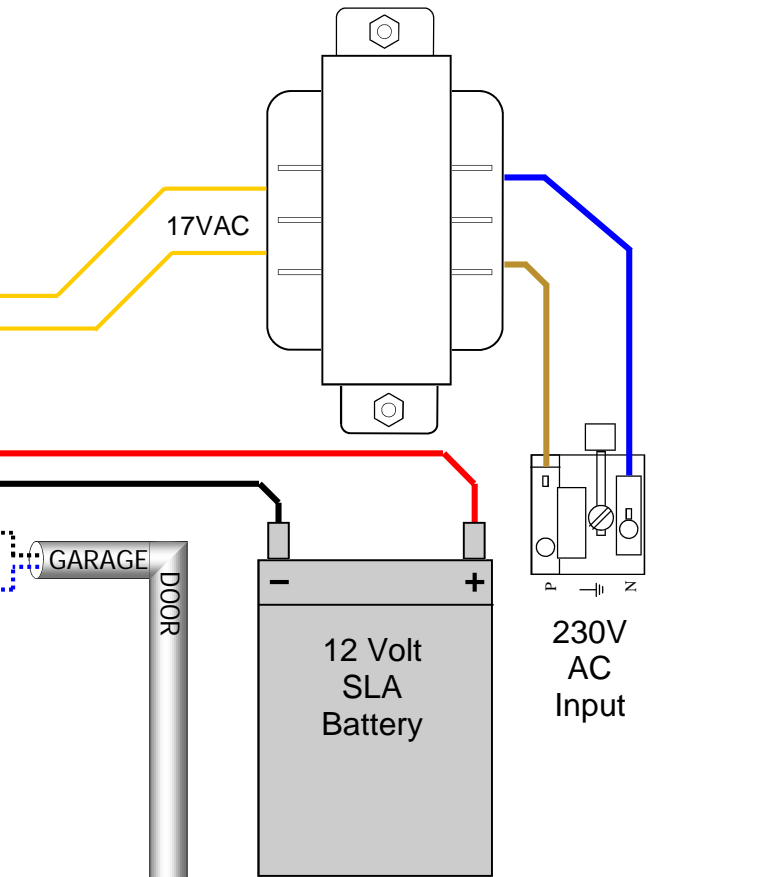
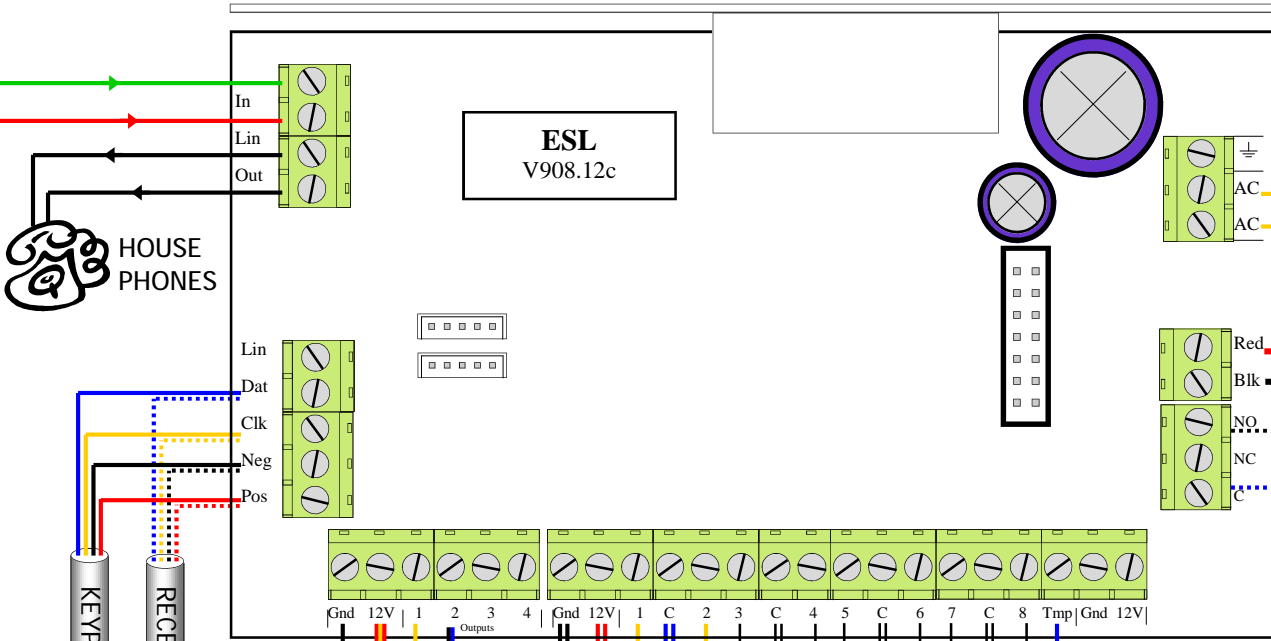
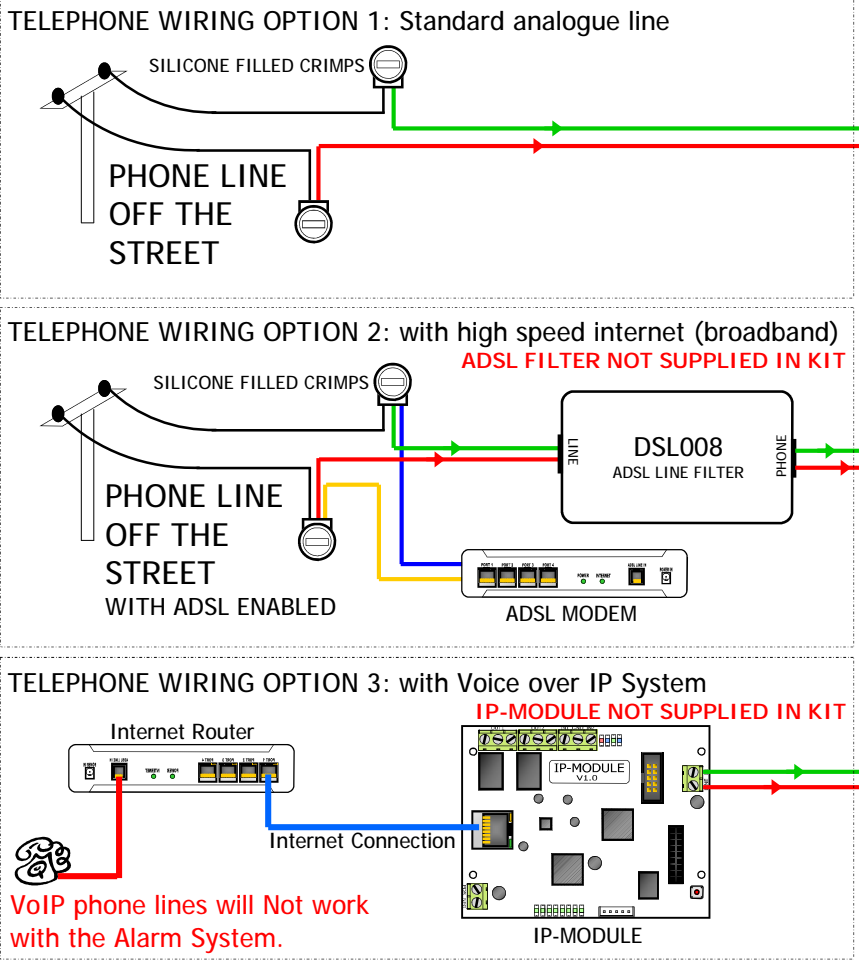

RESISTOR COLOUR CODES:

2K2 = [Red, Red, Red, Gold] = RED, RED, RED, GOLD.

4K7 = [Yellow, Violet, Red, Gold] = YELLOW, VIOLET, RED, GOLD.

8K2 = [Grey, Red, Red, Gold] = GREY, RED, RED, GOLD.